

Surface Mount Aluminum Electrolytic Capacitors NAZT Series

FEATURES

- CYLINDRICAL V-CHIP CONSTRUCTION FOR SURFACE MOUNTING
- AVAILABLE WITH ANTI-VIBRATION WIDE TERMINATIONS
- VERY LOW IMPEDANCE & HIGH RIPPLE CURRENT AT 100KHz
- EXTENDED LOAD LIFE (2,000 ~ 5,000 HOURS @ +105°C)
- SUITABLE FOR DC-DC CONVERTER, DC-AC INVERTER, ETC.
- DESIGNED FOR AUTOMATIC MOUNTING AND REFLOW SOLDERING
- MEETS THE REQUIREMENTS OF AEC-Q200*

SAC Alloy Compatible
230°C ~ 260°C



*Contact NIC for supporting test data

CHARACTERISTICS

Rated Voltage Rating	6.3 ~ 100Vdc									
Rated Capacitance Range	4.7 ~ 12,000µF									
Operating Temp. Range	-55 ~ +105°C									
Capacitance Tolerance	±20% (M)									
Max. Leakage Current After 2 Minutes @ 20°C	0.01CV or 3µA whichever is greater									
Tan δ @ 120Hz/20°C	W.V. (Vdc)	6.3	10	16	25	35	50	63	80	100
	S.V. (Vdc)	8.0	13	20	32	44	63	79	100	125
	4 ~ 6.3mm diameter	0.26	0.20	0.16	0.14	0.12	0.12	0.08	-	-
	8 ~ 18mm diameter	0.28	0.24	0.22	0.16	0.14	0.14	0.08	0.08	0.07
Low Temperature Stability Impedance Ratio @ 120Hz	W.V. (Vdc)	6.3	10	16	25	35	50	63	80	100
	Z-40°C/Z+20°C	3	3	3	3	3	3	2	2	2
	Z-55°C/Z+20°C	4	4	4	3	3	3	3	3	3
Load Life Test @ 105°C 4 ~ 6mm Dia. 2,000 hours 10x8mm Case Size 2,000 hours 8 ~ 18mm Dia. 5,000 hours	Capacitance Change	Within ±30% of initial measured value								
	Tan δ	Less than ±300% of the specified maximum value								
	Leakage Current	Less than the specified maximum value								

RoHS Compliant
includes all homogeneous materials

*See Part Number System for Details

LOW ESR COMPONENT
LIQUID ELECTROLYTE
For Performance Data see www.LowESR.com

STANDARD VALUES AND CASE SIZES (mm)

Cap. (µF)	Code	Working Voltage (Vdc)								
		6.3	10	16	25	35	50	63	80	100
4.7	4R7	-	-	-	-	4x6.3	4x6.3	-	-	-
10	100	-	-	-	4x6.3	5x6.3	6.3x6.3	6.3x6.3	-	-
15	150	-	-	4x6.3	5x6.3	5x6.3	6.3x6.3	-	-	-
22	220	-	4x6.3	5x6.3	5x6.3	5x6.3	6.3x6.3	6.3x8	-	-
27	270	4x6.3	5x6.3	5x6.3	6.3x6.3	6.3x6.3	6.3x6.3	6.3x8	-	-
33	330	5x6.3	5x6.3	6.3x6.3	6.3x6.3	6.3x6.3	6.3x8	-	-	10x10.5
47	470	5x6.3	6.3x6.3	6.3x6.3	6.3x6.3	6.3x6.3	6.3x8	10x8	10x10.5	12.5x14
56	560	5x6.3	6.3x6.3	6.3x6.3	6.3x6.3	6.3x8	8x10.5	-	-	-
68	680	6.3x6.3	6.3x6.3	6.3x6.3	6.3x6.3	6.3x8	8x10.5	-	-	12.5x14
100	101	5x6.3	6.3x6.3	6.3x6.3	6.3x8	6.3x8	8x10.5	12.5x14	12.5x14	16x17
		8x10.5				10x8				
150	151	6.3x6.3	6.3x6.3	6.3x8	8x10.5	8x10.5	10x10.5	12.5x14	12.5x14	16x17
						10x8				
220	221	6.3x6.3	6.3x8	6.3x8	8x10.5	8x10.5	10x10.5	12.5x14	-	18x17.5
					10x8					
330	331	6.3x8	8x10.5	8x10.5	8x10.5	10x10.5	12.5x14	16x17	16x17	18x22
				10x8						
470	471	8x10.5	8x10.5	8x10.5	10x10.5	10x14	16x17	16x17	18x17.5	-
		10x8	12.5x14							
680	681	8x10.5	10x10.5	10x10.5	10x14	12.5x14	16x17	18x17.5	-	-
		10x8			12.5x14					
1000	102	8x10.5	10x10.5	10x14	12.5x14	16x17	16x17	18x22	-	-
				12.5x14						
1200	122	-	-	-	-	-	18x17.5	-	-	-
1500	152	10x10.5	10x14	12.5x14	16x17	16x17	18x22	-	-	-
			12.5x14							
2200	222	12.5x14	12.5x14	-	16x17	18x17.5	-	-	-	-
2700	272	-	-	-	-	18x22	-	-	-	-
3300	332	-	-	16x17	18x17.5	-	-	-	-	-
3900	392	-	-	-	18x22	-	-	-	-	-
4700	472	-	16x17	18x17.5	-	-	-	-	-	-
5600	562	-	-	18x22	-	-	-	-	-	-
6800	682	16x17	18x17.5	-	-	-	-	-	-	-
8200	822	18x17.5	18x22	-	-	-	-	-	-	-
10000	103	18x17.5	-	-	-	-	-	-	-	-
12000	123	18x22	-	-	-	-	-	-	-	-



Surface Mount Aluminum Electrolytic Capacitors NAZT Series

STANDARD VALUES, CASE SIZES AND SPECIFICATIONS

NIC Part Number	Cap. (μF)	W.V. (Vdc)	Dissipation Factor (Tan δ)	Max. Impedance (Ω) 100KHz, +20°C	Max. Ripple Current (mA rms) +105°C, 100KHz	Load Life Hours @ +105°C
NAZT270M6.3V4X6.3NBF	27	6.3	0.26	1.45	90	2,000
NAZT330M6.3V5X6.3NBF	33		0.26	0.70	170	2,000
NAZT470M6.3V5X6.3NBF	47		0.26	0.70	170	2,000
NAZT560M6.3V5X6.3NBF	56		0.26	0.70	170	2,000
NAZT680M6.3V6.3X6.3NBF	68		0.26	0.39	250	2,000
NAZT101M6.3V5X6.3NBF	100		0.26	0.70	170	2,000
NAZT101M6.3V6.3X6.3NBF	100		0.26	0.39	250	2,000
NAZT151M6.3V6.3X6.3NBF	150		0.26	0.39	250	2,000
NAZT221M6.3V6.3X6.3NBF	220		0.26	0.39	250	2,000
NAZT331M6.3V6.3X8NBF	330		0.26	0.30	300	2,000
NAZT471M6.3V8X10.5NBF	470		0.28	0.17	600	5,000
NAZT681M6.3V8X10.5NBF	680		0.28	0.17	600	5,000
NAZT681M6.3V10X8JBF	680		0.28	0.17	600	2,000
NAZT102M6.3V8X10.5NBF	1000		0.28	0.17	600	5,000
NAZT152M6.3V10X10.5LBF	1500		0.28	0.09	850	5,000
NAZT222M6.3V12.5X14KLBF	2200		0.30	0.066	1100	5,000
NAZT682M6.3V16X17JLSF	6800		0.38	0.035	1800	5,000
NAZT822M6.3V18X17.5JLSF	8200		0.42	0.033	2060	5,000
NAZT103M6.3V18X17.5JLSF	10000		0.46	0.033	2060	5,000
NAZT123M6.3V18X22JLSF	12000		0.50	0.028	2260	5,000
NAZT220M10V4X6.3NBF	22	10	0.20	1.45	90	2,000
NAZT270M10V5X6.3NBF	27		0.20	0.70	170	2,000
NAZT330M10V5X6.3NBF	33		0.20	0.70	170	2,000
NAZT470M10V6.3X6.3NBF	47		0.20	0.39	250	2,000
NAZT560M10V6.3X6.3NBF	56		0.20	0.39	250	2,000
NAZT680M10V6.3X6.3NBF	68		0.20	0.39	250	2,000
NAZT101M10V6.3X6.3NBF	100		0.20	0.39	250	2,000
NAZT151M10V6.3X6.3NBF	150		0.20	0.39	250	2,000
NAZT221M10V6.3X8NBF	220		0.20	0.30	300	2,000
NAZT331M10V8X10.5NBF	330		0.24	0.17	600	5,000
NAZT471M10V8X10.5NBF	470		0.24	0.17	600	5,000
NAZT471M10V10X8JBF	470		0.24	0.17	600	2,000
NAZT681M10V10X10.5LBF	680		0.24	0.09	850	5,000
NAZT102M10V10X10.5LBF	1000		0.24	0.09	850	5,000
NAZT152M10V10X14LLBF	1500		0.24	0.07	950	5,000
NAZT152M10V12.5X14KLBF	1500		0.24	0.066	1100	5,000
NAZT222M10V12.5X14KLBF	2200		0.26	0.066	1100	5,000
NAZT472M10V16X17JLSF	4700		0.30	0.035	1800	5,000
NAZT682M10V18X17.5JLSF	6800		0.34	0.033	2060	5,000
NAZT822M10V18X22JLSF	8200		0.38	0.028	2260	5,000
NAZT150M16V4X6.3NBF	15	16	0.16	1.45	90	2,000
NAZT220M16V5X6.3NBF	22		0.16	0.70	170	2,000
NAZT270M16V5X6.3NBF	27		0.16	0.70	170	2,000
NAZT330M16V6.3X6.3NBF	33		0.16	0.39	250	2,000
NAZT470M16V6.3X6.3NBF	47		0.16	0.39	250	2,000
NAZT560M16V6.3X6.3NBF	56		0.16	0.39	250	2,000
NAZT680M16V6.3X6.3NBF	68		0.16	0.39	250	2,000
NAZT101M16V6.3X6.3NBF	100		0.16	0.39	250	2,000
NAZT151M16V6.3X8NBF	150		0.16	0.30	300	2,000
NAZT221M16V6.3X8NBF	220		0.16	0.30	300	2,000
NAZT331M16V8X10.5NBF	330		0.22	0.17	600	5,000
NAZT331M16V10X8JBF	330		0.22	0.17	600	2,000
NAZT471M16V8X10.5NBF	470		0.22	0.17	600	5,000
NAZT681M16V10X10.5LBF	680		0.22	0.09	850	5,000
NAZT102M16V10X14LLBF	1000		0.22	0.07	950	5,000
NAZT102M16V12.5X14KLBF	1000		0.22	0.066	1100	5,000
NAZT152M16V12.5X14KLBF	1500		0.22	0.06	1100	5,000
NAZT332M16V16X17JLSF	3300		0.26	0.035	1800	5,000
NAZT472M16V18X17.5JLSF	4700		0.28	0.033	2060	5,000
NAZT562M16V18X22JLSF	5600		0.30	0.028	2260	5,000

For Automotive Equipment, see part number system



Surface Mount Aluminum Electrolytic Capacitors NAZT Series

STANDARD VALUES, CASE SIZES AND SPECIFICATIONS

NIC Part Number	Cap. (µF)	W.V. (Vdc)	Dissipation Factor (Tan δ)	Max. Impedance (Ω) 100KHz, +20°C	Max. Ripple Current (mA rms) +105°C, 100KHz	Load Life Hours @ +105°C
NAZT100M25V4X6.3NBF	10	25	0.14	1.45	90	2,000
NAZT150M25V5X6.3NBF	15		0.14	0.70	170	2,000
NAZT220M25V5X6.3NBF	22		0.14	0.70	170	2,000
NAZT270M25V6.3X6.3NBF	27		0.14	0.39	250	2,000
NAZT330M25V6.3X6.3NBF	33		0.14	0.39	250	2,000
NAZT470M25V6.3X6.3NBF	47		0.14	0.39	250	2,000
NAZT560M25V6.3X6.3NBF	56		0.14	0.39	250	2,000
NAZT680M25V6.3X6.3NBF	68		0.14	0.39	250	2,000
NAZT101M25V6.3X8NBF	100		0.14	0.30	300	2,000
NAZT151M25V8X10.5NBF	150		0.16	0.17	600	5,000
NAZT221M25V8X10.5NBF	220		0.16	0.17	600	5,000
NAZT221M25V10X8JBF	220		0.16	0.17	600	2,000
NAZT331M25V8X10.5NBF	330		0.16	0.17	600	5,000
NAZT471M25V10X10.5LBF	470		0.16	0.09	850	5,000
NAZT681M25V10X14LLBF	680		0.16	0.07	950	5,000
NAZT681M25V12.5X14KLBF	680		0.16	0.066	1100	5,000
NAZT102M25V12.5X14KLBF	1000		0.16	0.066	1100	5,000
NAZT152M25V16X17JLSF	1500		0.16	0.035	1800	5,000
NAZT222M25V16X17JLSF	2200		0.18	0.035	1800	5,000
NAZT332M25V18X17.5JLSF	3300		0.20	0.033	2060	5,000
NAZT392M25V18X22JLSF	3900	0.20	0.028	2260	5,000	
NAZT4R7M35V4X6.3NBF	4.7	35	0.12	1.45	90	2,000
NAZT100M35V5X6.3NBF	10		0.12	0.70	170	2,000
NAZT150M35V5X6.3NBF	15		0.12	0.70	170	2,000
NAZT220M35V5X6.3NBF	22		0.12	0.70	170	2,000
NAZT270M35V6.3X6.3NBF	27		0.12	0.39	250	2,000
NAZT330M35V6.3X6.3NBF	33		0.12	0.39	250	2,000
NAZT470M35V6.3X6.3NBF	47		0.12	0.39	250	2,000
NAZT560M35V6.3X8NBF	56		0.12	0.30	300	2,000
NAZT680M35V6.3X8NBF	68		0.12	0.30	300	2,000
NAZT101M35V6.3X8NBF	100		0.12	0.30	300	2,000
NAZT101M35V8X10.5NBF	100		0.14	0.17	600	5,000
NAZT151M35V8X10.5NBF	150		0.14	0.17	600	5,000
NAZT151M35V10X8JBF	150		0.14	0.17	600	2,000
NAZT221M35V8X10.5NBF	220		0.14	0.17	600	5,000
NAZT331M35V10X10.5LBF	330		0.14	0.09	850	5,000
NAZT471M35V10X14LLBF	470		0.14	0.07	950	5,000
NAZT471M35V12.5X14KLBF	470		0.14	0.066	1100	5,000
NAZT681M35V12.5X14KLBF	680		0.14	0.066	1100	5,000
NAZT102M35V16X17JLSF	1000		0.14	0.035	1800	5,000
NAZT152M35V16X17JLSF	1500		0.14	0.035	1800	5,000
NAZT222M35V18X17.5JLSF	2200	0.16	0.033	2060	5,000	
NAZT272M35V18X22JLSF	2700	0.16	0.028	2260	5,000	
NAZT4R7M50V4X6.3NBF	4.7	50	0.12	2.90	60	2,000
NAZT100M50V6.3X6.3NBF	10		0.12	0.88	165	2,000
NAZT150M50V6.3X6.3NBF	15		0.12	0.88	165	2,000
NAZT220M50V6.3X6.3NBF	22		0.12	0.88	165	2,000
NAZT270M50V6.3X8NBF	27		0.12	0.68	195	2,000
NAZT330M50V6.3X8NBF	33		0.12	0.68	195	2,000
NAZT470M50V6.3X8NBF	47		0.12	0.68	195	2,000
NAZT560M50V8X10.5NBF	56		0.14	0.34	350	5,000
NAZT680M50V8X10.5NBF	68		0.14	0.34	350	5,000
NAZT101M50V8X10.5NBF	100		0.14	0.34	350	5,000
NAZT101M50V10X8JBF	100		0.14	0.34	330	2,000
NAZT151M50V10X10.5LBF	150		0.14	0.18	670	5,000
NAZT221M50V10X10.5LBF	220		0.14	0.18	670	5,000
NAZT331M50V12.5X14KLBF	330		0.14	0.12	900	5,000
NAZT471M50V16X17JLSF	470		0.14	0.073	1610	5,000
NAZT681M50V16X17JLSF	680		0.14	0.073	1610	5,000
NAZT102M50V16X17JLSF	1000		0.14	0.073	1610	5,000
NAZT122M50V18X17.5JLSF	1200		0.14	0.068	1900	5,000
NAZT152M50V18X22JLSF	1500		0.14	0.042	2180	5,000

For Automotive Equipment, see part number system



Surface Mount Aluminum Electrolytic Capacitors NAZT Series

STANDARD VALUES, CASE SIZES AND SPECIFICATIONS

NIC Part Number	Cap. (μF)	W.V. (Vdc)	Dissipation Factor (Tan δ)	Max. Impedance (Ω) 100KHz, +20°C	Max. Ripple Current (mA rms) +105°C, 100KHz	Load Life Hours @ +105°C
NAZT100M63V6.3X6.3LBF	10	63	0.08	1.50	80	2,000
NAZT220M63V6.3X8LBF	22		0.08	1.20	120	2,000
NAZT470M63V10X8JBF	47		0.08	0.70	200	2,000
NAZT101M63V12.5X14JLBF	100		0.08	0.16	800	5,000
NAZT151M63V12.5X14JLBF	150		0.08	0.16	800	5,000
NAZT221M63V12.5X14JLBF	220		0.08	0.16	800	5,000
NAZT331M63V16X17HLSF	330		0.08	0.082	1410	5,000
NAZT471M63V16X17HLSF	470		0.08	0.082	1410	5,000
NAZT681M63V18X17.5HLSF	680		0.08	0.080	1690	5,000
NAZT102M63V18X22HLSF	1000		0.08	0.055	1960	5,000
NAZT470M80V10X10.5JBF	47	80	0.08	0.65	200	5,000
NAZT101M80V12.5X14HLBF	100		0.08	0.32	500	5,000
NAZT151M80V12.5X14HLBF	150		0.08	0.32	500	5,000
NAZT331M80V16X17HLSF	330		0.08	0.17	793	5,000
NAZT471M80V18X17.5HLSF	470		0.08	0.153	917	5,000
NAZT330M100V10X10.5JBF	33	100	0.07	0.65	200	5,000
NAZT470M100V12.5X14HLBF	47		0.07	0.32	500	5,000
NAZT680M100V12.5X14HLBF	68		0.07	0.32	500	5,000
NAZT101M100V16X17HLSF	100		0.07	0.17	793	5,000
NAZT151M100V16X17HLSF	150		0.07	0.17	793	5,000
NAZT221M100V18X17.5HLSF	220		0.07	0.153	917	5,000
NAZT331M100V18X22HLSF	330		0.07	0.083	1230	5,000

For Automotive Equipment, see part number system

RIPPLE CURRENT FREQUENCY CORRECTION FACTORS

Frequency	100≤F<1KHz	1K≤F<10KHz	10K≤F<100KHz	100KHz≤F
C≤33μF	0.35	0.70	0.90	1.00
33μF<C≤150μF	0.40	0.85	0.92	1.00
150μF<C	0.60	0.85	0.95	1.00

DIMENSIONS (mm) AND REEL QUANTITIES

Case Size	φD±0.5	L max.	A±0.2	B±0.2	I±0.3	W	P±0.3	Qty/Reel	
								TR13 (330mm)	TR15 (380mm)
4x6.3	4.0	6.3	4.3	4.3	1.8	0.5~0.8	1.0	1,200	2,000
5x6.3	5.0	6.3	5.3	5.3	2.2	0.5~0.8	1.4	800	1,000
6.3x6.3	6.3	6.3	6.6	6.6	2.5	0.5~0.8	2.2	800	1,000
6.3x8	6.3	8.0	6.6	6.6	2.5	0.5~0.8	2.2	500	900
8x10.5	8.0	10.5	8.3	8.3	2.9	0.7~1.1	3.2	300	500
10x8	10.0	8.0	10.3	10.3	3.2	0.7~1.4	4.6	400	500
10x10.5	10.0	10.5	10.3	10.3	3.2	0.7~1.4	4.6	300	500
10x14	10.0	14	10.3	10.3	3.2	0.7~1.4	4.6	-	400
12.5x14	12.5	14.0	12.8	12.8	4.5	1.0~1.4	4.6	-	250
16x17	16.0	17.0	16.3	16.3	5.2	1.7~2.1	7.0	-	200
18x17.5	18	17.5	19.0	19.0	6.5	1.7~2.1	7.0	-	175
18x22	18	22.0	19.0	19.0	6.5	1.7~2.1	7.0	-	125

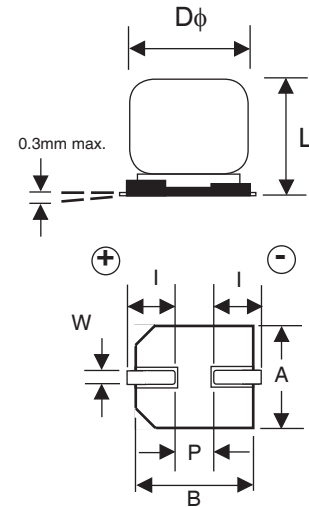

PART NUMBER SYSTEM

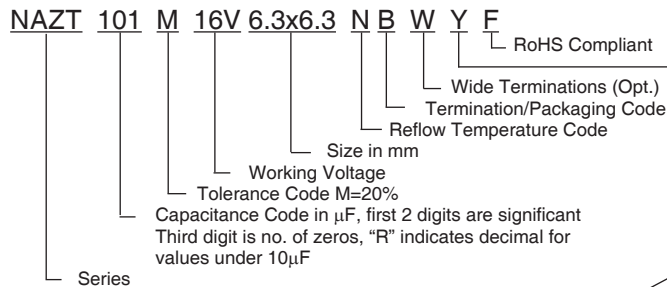

Optional: Suitable for automotive equipment, sourced to special production and inspection at TS-16949 certified production site



Surface Mount Aluminum Electrolytic Capacitors NAZT Series

REFLOW TEMPERATURES AND DURATION

Voltage	Diameter	Time above 200°C	Time above 217°C	Time above 230°C	Peak Temperature 5 seconds
6.3 ~ 50V	4 ~ 8mm ϕ	80 sec. max.	70 sec. max.	40 sec. max.	See Part Number Suffix and Peak Reflow Temperature Table
	10x8	50 sec. max.	40 sec. max.	20 sec. max.	
	10mm ϕ	70 sec. max.	60 sec. max.	40 sec. max.	
	12.5mm ϕ	60 sec. max.	50 sec. max.	30 sec. max.	
	16 ~ 18mm ϕ	50 sec. max.	40 sec. max.	20 sec. max.	
63V	6.3mm ϕ	70 sec. max.	60 sec. max.	40 sec. max.	
	10 ~ 12.5mm ϕ	50 sec. max.	40 sec. max.	20 sec. max.	
	16 ~ 18mm ϕ	50 sec. max.	40 sec. max.	15 sec. max.	
80V, 100V	10mm ϕ	50 sec. max.	40 sec. max.	20 sec. max.	
	12.5mm ϕ	50 sec. max.	40 sec. max.	20 sec. max.	
	16 ~ 18mm ϕ	45 sec. max.	30 sec. max.	10 sec. max.	

Capacitors can withstand two times reflow at the above conditions. Second reflow shall be at least one hour after natural cool to room temperature.

PEAK REFLOW TEMPERATURE CODES

Code	Peak Reflow Temperature
N	260°C
L	250°C
K	245°C
J	240°C
H	235°C

TERMINATION FINISH & PACKAGING OPTIONS CODES

Code	Finish & Reel Size
B	Sn-Bi Finish & 13" Reel
LB	Sn-Bi Finish & 15" Reel
S	100% Sn Finish & 13" Reel
LS	100% Sn Finish & 15" Reel

Note: 16mm & 18mm diameter parts are only available with Sn finish.

STANDARD TERMINAL LAND PATTERN DIMENSIONS (mm)

Case Size	a	b	c
4x6.3	1.0	2.6	1.8
5x6.3	1.4	3.0	1.8
6x3x6.3 6.3x8	2.1	3.5	1.8
8x10.5	2.8	4.1	2.1
10x8	4.3	4.4	2.5
10x10.5	4.3	5.8	2.5
10x14	4.3	5.8	2.5
12.5x14	6.6	6.5	5.0
16x17	6.6	7.7	5.0
18x22	6.6	7.7	5.0

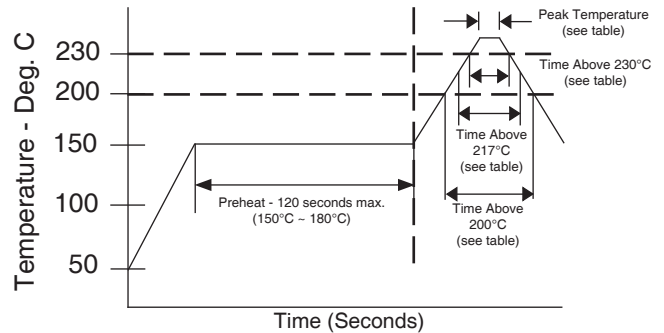
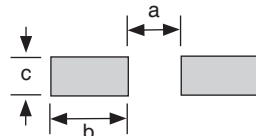

WIDE TERMINATION (WT) DIM. (mm)

Case Size	D ϕ \pm 0.5	L	A, B	C \pm 0.2	P \pm 0.2	W	R	T
8x10.5WT	8.0	10.5 \pm 0.5	8.3 \pm 0.2	9.0	3.2	0.7 ~ 1.0	(0.7)	(1.3)
10x10.5WT	10.0	10.5 \pm 0.5	10.3 \pm 0.2	11.0	4.6	1.0 ~ 1.4	(0.7)	(1.3)
10x14WT	10.0	14.0 +0.5/-1.5	10.3 \pm 0.2	11.0	4.6	1.0 ~ 1.4	(0.7)	(1.3)
12.5x14WT	12.5	14.0 +0.5/-1.5	13.5 \pm 0.2	14.2	4.6	1.0 ~ 1.4	(2.2)	(2.4)
16x17WT	16.0	17.0 +0.5/-1.5	17.0 \pm 0.2	18.0	7.0	1.8 ~ 2.1	(3.0)	(2.0)
18x17.5WT	18.0	17.5 +0/-2.0	19.0 \pm 0.2	20.0	7.0	1.7 ~ 2.1	(3.0)	(2.0)
18x22WT	18.0	22.0 +0/-2.0	19.0 \pm 0.2	20.0	7.0	1.7 ~ 2.1	(3.0)	(2.0)

WT LAND PATTERN DIM. (mm)

Case Size	a	b	c
8x10.5WT	2.5	4.5	4.7
10x10.5WT	3.8	4.8	4.7
10x14WT	3.8	4.8	4.7
10x14WT	3.8	4.8	4.7
12.5x14WT	3.8	6.1	6.9
16x17WT	5.0	8.0	9.5
18x17.5WT	5.0	8.6	9.5
18x22WT	5.0	8.6	9.5

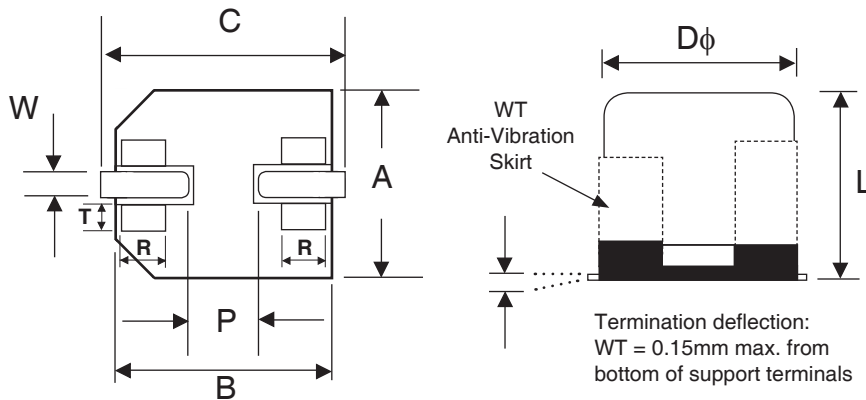

Review & Compare Reflow Soldering Heat Limits
V-chip SMT Aluminum Electrolytic Capacitors
www.niccomp.com/RSL



Surface Mount Aluminum Electrolytic Capacitors NAZT Series

WT STYLE VIBRATION SPECIFICATION

Test Method	Characteristic	Standard
1) Direction & Duration of Vibration: Two (2) hours in X, Y, Z axis 2) Frequency: 5Hz ~ 2,000Hz reciprocation for 20 minutes 3) Peak to Peak Amplitude: 5mm 4) Peak Acceleration: 30G 5) Sweep Type: Log 6) Thickness of Solder Paste: 0.20mm ± 0.03mm	Capacitance Change	Within ± 10% of the initial measured value
	Dissipation Factor (Tan δ)	Less than specified maximum value
	Leakage Current	Less than specified maximum value

TAPING SPECIFICATIONS (mm)

- Both Leader and Trailer tape: Minimum 10 empty carrier tape pockets.
- Connection: Maximum 3 connections (slices) per reel.

Case Size	A ±0.2	B ±0.2	C ±0.3	D ±0.1	P ±0.1	T ±0.2	t max.	S ±0.1
4x6.3	4.7	4.7	12.0	5.5	8.0	6.4	0.6	-
5x6.3	5.7	5.7	12.0	5.5	12.0	6.4	0.6	-
6.3x6.3	7.0	7.0	16.0	7.5	12.0	6.5	0.6	-
6.3x8	7.0	7.0	16.0	7.5	12.0	8.2	0.6	-
8x10.5	8.7	8.7	24.0	11.5	16.0	11.1	0.6	-
10x8	10.7	10.7	24.0	11.5	16.0	8.3	0.6	-
10x10.5	10.7	10.7	24.0	11.5	16.0	11.2	0.6	-
10x14	10.7	10.7	24.0	11.5	16.0	14.6	0.6	-
12.5x14	13.2	13.2	32.0	14.2	24.0	14.3	0.6	28.4
16x17	17.5	17.5	44.0	20.2	28.0	17.3	0.6	40.4
18x17	19.5	19.5	44.0	20.2	32.0	17.8	0.6	40.4
18x22	19.5	19.5	44.0	20.2	32.0	22.5	0.6	40.4

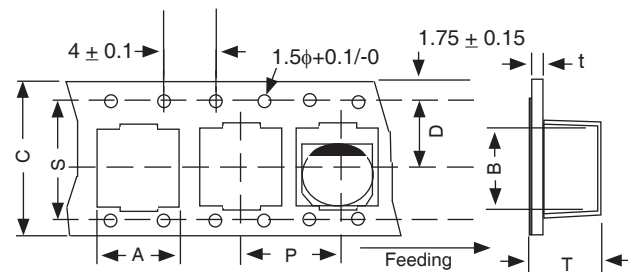

WT TAPING SPECIFICATIONS (mm)

- Both Leader and Trailer tape: Minimum 10 empty carrier tape pockets.
- Connection: Maximum 3 connections (slices) per reel.

Case Size	A ±0.2	B ±0.2	C ±0.3	D ±0.1	P ±0.1	T ±0.2	t max.	S ±0.1
8x10.5	8.7	8.7	24.0	11.5	16.0	11.1	0.6	-
10x8	10.7	10.7	24.0	11.5	16.0	8.3	0.6	-
10x10.5	10.7	10.7	24.0	11.5	16.0	11.2	0.6	-
10x14	10.7	10.7	24.0	11.5	16.0	14.6	0.6	-
12.5x14	13.9	13.9	32.0	14.2	24.0	14.7	0.6	28.4
16x17	17.5	17.5	44.0	20.2	28.0	17.8	0.6	40.4
18x17	19.5	19.5	44.0	20.2	32.0	17.8	0.6	40.4
18x22	19.5	19.5	44.0	20.2	32.0	22.5	0.6	40.4

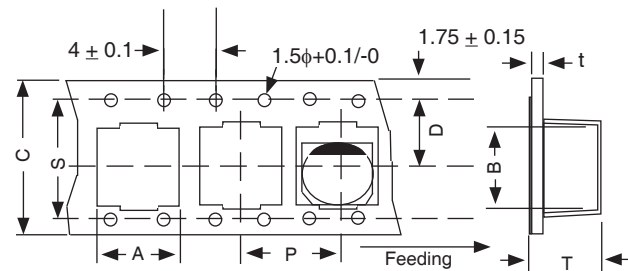

REEL DIMENSIONS (mm)

Case Size	W ±1.0	Qty per Reel	
		13" (330mm)	15" (380mm)
4x6.3	14	1200	2000
5x6.3	14	800	1000
6.3x6.3	18	800	1000
6.3x8	18	500	900
8x10.5	26	300	500
10x8	26	400	500
10x10.5	26	300	500
10x14	26	-	400
12.5x14	34	-	250
16x17	46	-	200
18x17	46	-	175
18x22	46	-	125

